

C

Reg. No. :

|  |  |  |  |  |  |  |  |  |  |  |  |  |  |  |
|--|--|--|--|--|--|--|--|--|--|--|--|--|--|--|
|  |  |  |  |  |  |  |  |  |  |  |  |  |  |  |
|--|--|--|--|--|--|--|--|--|--|--|--|--|--|--|

**Question Paper Code: U2104**

B.E./B.Tech. DEGREE EXAMINATION, MAY 2024

Second Semester

Civil Engineering

21UCE204- Engineering Mechanics

(Regulations 2021)

Duration: Three hours

Maximum: 100 Marks

Answer All Questions

PART A - (5x 1 = 5 Marks)

1. The velocity ratio in case of an inclined plane inclined at angle ' $\theta$ ' to the horizontal and weight being pulled up the inclined plane by vertical effort is  
(a)  $\sin\theta$  (b)  $\cos\theta$  (c)  $\tan\theta$  (d)  $\operatorname{cosec}\theta$  CO1- U
2. The \_\_\_\_\_ forces do not cause the rotation. CO2- U  
(a) Non-concurrent (b) Concurrent (c) Parallel (d) Non-Parallel
3. What is the Centroidal distance of an equilateral triangle of side 2 m? CO3- App  
(a) 0.866m (b) 0.769m (c) 1.000m (d) 0.577m
4. A cubical block rests on an inclined plane of  $\mu = 1/\sqrt{3}$ , determine the angle of inclination when the block just slides down the inclined plane? CO1- U  
(a)  $40^\circ$  (b)  $50^\circ$  (c)  $30^\circ$  (d)  $20^\circ$
5. If we place some coins over the paper strip and pull it with a jerk, then coins don't fall off because of CO5- U  
(a) friction (b) inertia (c) resistance (d) force

PART – B (5 x 3= 15Marks)

6. Draw free body diagram for given fig. CO1- U

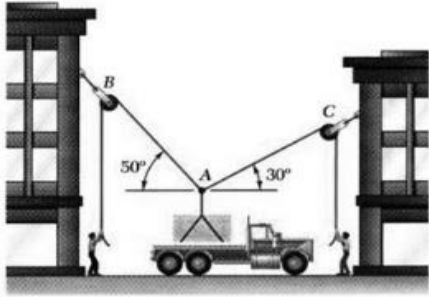

- 7. Sketch the different types of supports with support reactions CO1- U
- 8. Differentiate Centroid and Center of Gravity. CO1- U
- 9. Define dynamic friction and static friction CO2- App
- 10. Define Rolling resistance CO1- U

PART – C (5 x 16= 80Marks)

11. (a) The resultant of the forces system shown in figure is 520N along the negative direction of Y axis. Determine P and  $\theta$ . CO2-App (16)

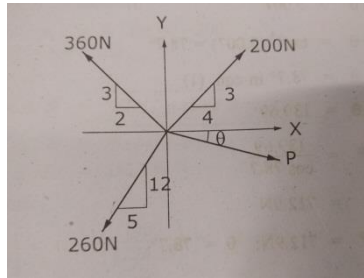

Or

- (b) A girl is sitting on an automobile tire which is suspended as shown in fig. CO2-App (16)  
 If the girl and the tire together have a mass of 60 kg.  
 Determine (i) The tension in the rope AC (ii) The tension in the rope BC

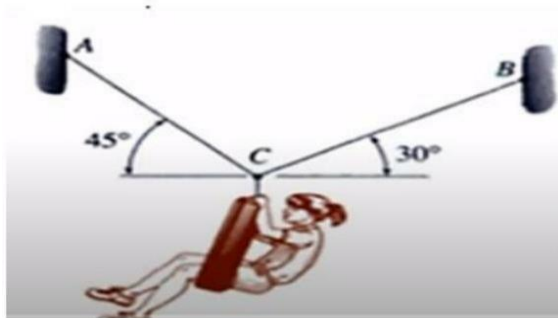

12. (a) Find the simplest equivalent force for the system of forces acting on the beam shown in fig. CO4-Ana (16)

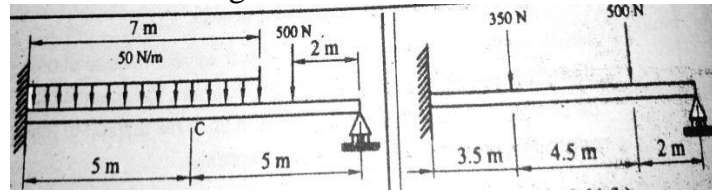

Or

- (b) Blocks A and B of weight 200N and 100N respectively, rest on a  $30^\circ$  inclined plane and are attached to the post which is held perpendicular to the plane by force P, parallel to the plane, as shown in fig. Assume that all surfaces are smooth and that the cords are parallel to the plane. Determine the value of P. Also find the normal reactions of blocks A and B CO4-Ana (16)

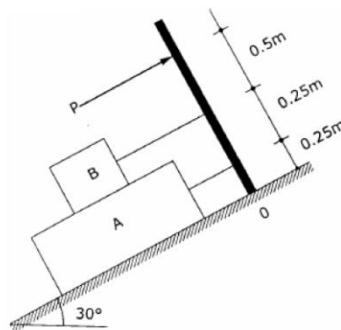

13. (a) Locate the centroid of the given T Section as shown in fig. CO3-App (16)

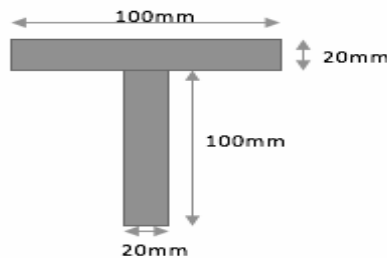

Or

- (b) Find the moment of inertia of a channel section as shown in fig, CO3-App (16)

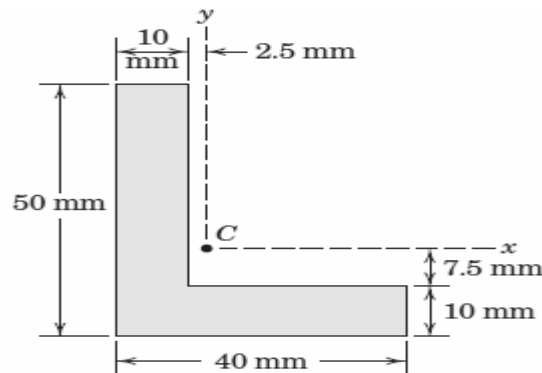

14. (a) A 7m long ladder rests against a vertical wall, with which it makes an angle of  $45^\circ$  and on a floor. If a man whose weight is one half that of the ladder climbs it, at what distance along the ladder will he be, when the ladder is about to slip? Take coeff. of friction between the ladder and the wall is  $\frac{1}{3}$  and that between the ladder and the floor is  $\frac{1}{2}$ . CO4-Ana (16)

Or

- (b) A body of weight 100N is placed on a rough horizontal plane and pushed by a force of 45N as shown in fig. to just cause sliding over the horizontal plane. Determine the coefficient of friction in all the three cases. CO4-Ana (16)

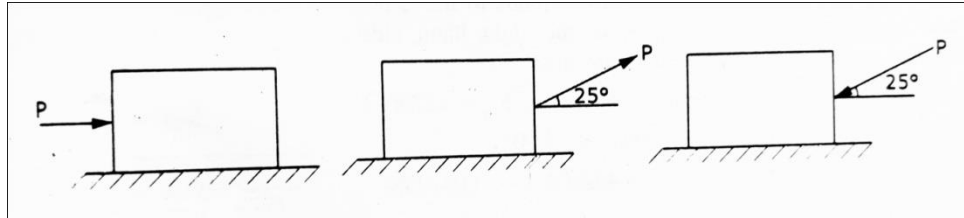

15. (a) A body of mass 15kg is initially at rest on a  $10^\circ$  inclined plane. Then it slides down. Calculate the distance moved by the body, on the inclined plane, when the velocity reaches to 6m/s. The coefficient of friction between the body and the plane is 0.1 CO2-App (16)

Or

- (b) An elevator of weight (including the weight of man) 4.5kN starts moving upwards with a constant acceleration and acquires a velocity of 1.8 m/s, after travelling a distance of 2m. Find the pull in the cable during accelerated motion. CO2-App (16)